

## Dual N-Channel Enhancement Mode Field Effect Transistor

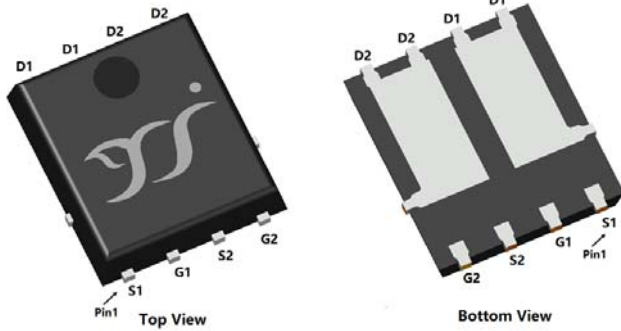

PDFN5060-8L

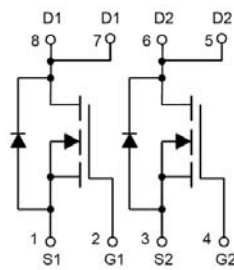

### Product Summary

- $V_{DS}$  60V
- $I_D$  52A
- $R_{DS(ON)}$ ( at  $V_{GS}=10V$ )  $< 11m\Omega$
- $R_{DS(ON)}$ ( at  $V_{GS}=4.5V$ )  $< 16m\Omega$
- 100% EAS Tested
- 100%  $\nabla V_{DS}$  Tested

### General Description

- Excellent package for heat dissipation
- High density cell design for low  $R_{DS(ON)}$
- Moisture Sensitivity Level 1
- Epoxy Meets UL 94 V-0 Flammability Rating
- Part no. with suffix "Q" means AEC-Q101 qualified
- Halogen Free

### Applications

- Power switching application
- Uninterruptible power supply
- DC-DC convertor

### Limiting Values

Parameter	Conditions		Symbol	Min	Max	Unit
Drain-source Voltage			$V_{DS}$	-	60	V
Gate-source Voltage			$V_{GS}$	-20	20	
Continuous Drain Current (Note 1,2)	Steady-State	$T_A=25^\circ C, V_{GS}=10V$	$I_D$	-	11	A
		$T_A=100^\circ C, V_{GS}=10V$		-	7.6	
Continuous Drain Current (Note 1,3)	Steady-State	$T_C=25^\circ C, V_{GS}=10V, \text{Chip limitation}$		-	52	
		$T_C=100^\circ C, V_{GS}=10V$		-	37	
Pulsed Drain Current	$T_C=25^\circ C, t_p \leq 10\mu s$		$I_{DM}$	-	182	
Maximum Body-Diode Continuous Current	$T_C=25^\circ C$		$I_S$		45	
Avalanche energy (non-repetitive)	$T_J=25^\circ C, V_G=10V, R_G=25\Omega, L=0.5mH, I_{AS}=12A$		EAS	-	36	mJ
Total Power Dissipation (Note 1,2)	Steady-State	$T_A=25^\circ C$	$P_D$	-	2.4	W
		$T_A=100^\circ C$		-	1.2	
Total Power Dissipation (Note 1,3)	Steady-State	$T_C=25^\circ C$		-	56	
		$T_C=100^\circ C$		-	28	
Junction and Storage Temperature Range			$T_J, T_{STG}$	-55	175	$^\circ C$

### Thermal Resistance

Parameter		Symbol	Typ	Max	Units
Thermal Resistance Junction-to-Ambient (Note 2)	Steady-State	$R_{\theta JA}$	-	62	$^\circ C/W$
Thermal Resistance Junction-to-Case	Steady-State	$R_{\theta JC}$	-	2.7	

### Ordering Information (Example)

PREFERRED P/N	PACKING CODE	Marking	MINIMUM PACKAGE(pcs)	INNER BOX QUANTITY(pcs)	OUTER CARTON QUANTITY(pcs)	DELIVERY MODE
YJGD011G06AQ	F1	YJGD011G06A	5000	10000	100000	13" reel



# YJGD011G06AQ

## ■ Electrical Characteristics

Parameter	Symbol	Conditions	Min	Typ	Max	Units
<b>Static Parameter</b>						
Drain-Source Breakdown Voltage	$BV_{DSS}$	$V_{GS}=0V, I_D=250\mu A, T_j=25^\circ C$	60	-	-	V
		$V_{GS}=0V, I_D=1mA, T_j=25^\circ C$	60	-	-	
Zero Gate Voltage Drain Current	$I_{DSS}$	$V_{DS}=60V, V_{GS}=0V, T_j=25^\circ C$	-	-	1	$\mu A$
		$V_{DS}=60V, V_{GS}=0V, T_j=150^\circ C$	-	-	100	
Gate-Source Leakage Current	$I_{GSS}$	$V_{GS}=\pm 20V, V_{DS}=0V, T_j=25^\circ C$	-	-	$\pm 100$	nA
Gate Threshold Voltage	$V_{GS(th)}$	$V_{DS}=V_{GS}, I_D=250\mu A, T_j=25^\circ C$	1.3	1.8	2.4	V
Static Drain-Source On-Resistance	$R_{DS(on)}$	$V_{GS}=10V, I_D=20A, T_j=25^\circ C$	-	8.6	11	m $\Omega$
		$V_{GS}=4.5V, I_D=15A, T_j=25^\circ C$	-	11.9	16	
Diode Forward Voltage	$V_{SD}$	$I_S=20A, V_{GS}=0V, T_j=25^\circ C$	-	0.84	1.2	V
Gate Resistance	$R_G$	$f=1MHz, T_j=25^\circ C$	-	1.7	-	$\Omega$
<b>Dynamic Parameters</b>						
Input Capacitance	$C_{iss}$	$V_{DS}=30V, V_{GS}=0V, f=1MHz, T_j=25^\circ C$	-	910	-	$\mu F$
Output Capacitance	$C_{oss}$		-	316	-	
Reverse Transfer Capacitance	$C_{riss}$		-	17	-	
<b>Switching Parameters</b>						
Total Gate Charge	$Q_g$	$V_{GS}=10V, V_{DS}=30V, I_D=20A, T_j=25^\circ C$	-	15.8	-	nC
Gate-Source Charge	$Q_{gs}$		-	3.1	-	
Gate-Drain Charge	$Q_{gd}$		-	3.5	-	
Reverse Recovery Charge	$Q_{rr}$	$I_F=20A, di/dt=100A/\mu s, V_{GS}=0V, V_R=30V, T_j=25^\circ C$	-	9	-	nC
Reverse Recovery Time	$t_{rr}$		-	17.7	-	ns
Turn-on Delay Time	$t_{D(on)}$	$V_{GS}=10V, V_{DS}=30V, I_D=20A, R_{GEN}=3\Omega, T_j=25^\circ C$	-	8	-	ns
Turn-on Rise Time	$t_r$		-	44.6	-	
Turn-off Delay Time	$t_{D(off)}$		-	19.8	-	
Turn-off Fall Time	$t_f$		-	6.4	-	

### Note:

- The entire application environment impacts the thermal resistance values shown, they are not constants and are only valid for the particular conditions noted.
- The value of  $R_{\theta JA}$  is measured with the device mounted on the 40mm\*40mm\*1.1mm single layer FR-4 PCB board with 1 in<sup>2</sup> pad of 2oz. Copper, in the still air environment with  $T_A=25^\circ C$ . The maximum allowed junction temperature of  $175^\circ C$ . The value in any given application depends on the user's specific board design.
- Thermal resistance from junction to soldering point (on the exposed drain pad).



## Typical Electrical and Thermal Characteristics Diagrams

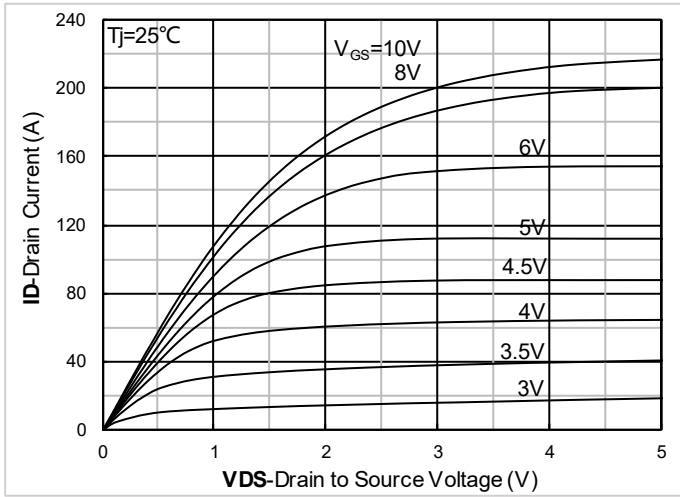

Figure 1. Output Characteristics; typical values

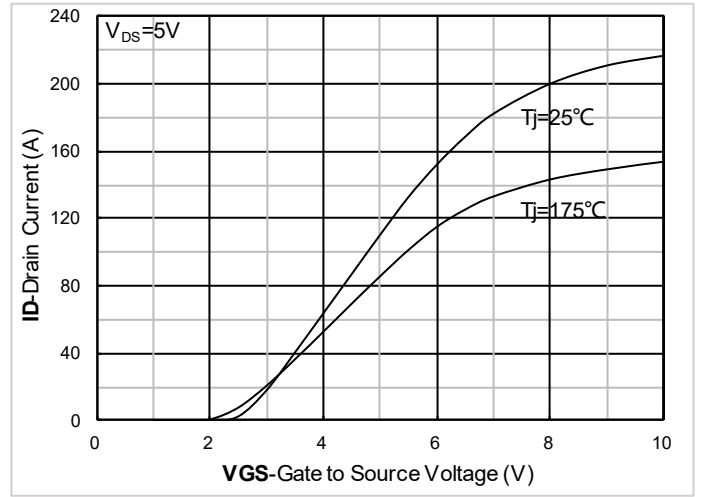

Figure 2. Transfer Characteristics; typical values

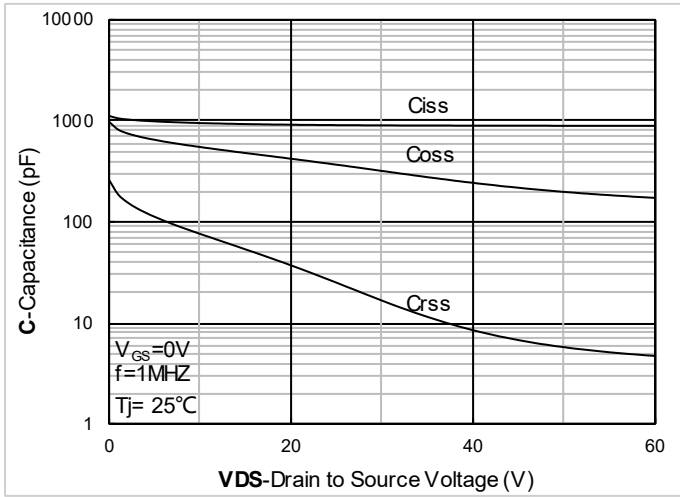

Figure 3. Capacitance Characteristics; typical values

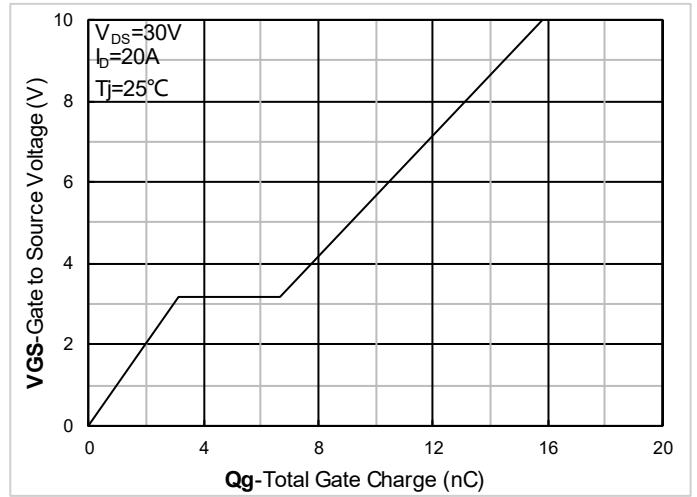

Figure 4. Gate Charge; typical values

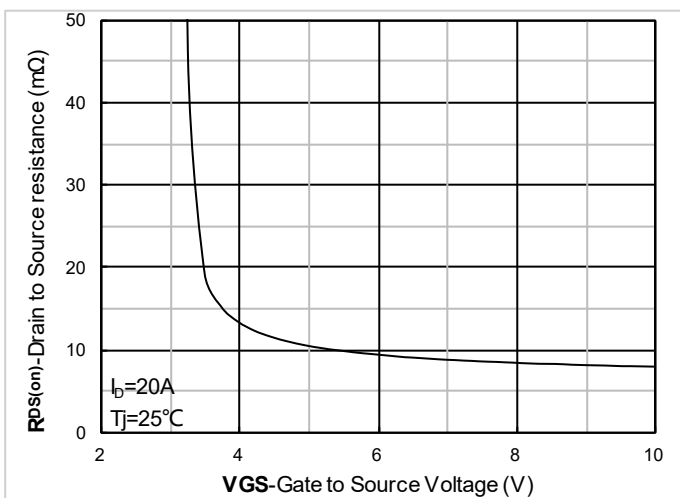

Figure 5. On-Resistance vs. Gate to Source Voltage; typical values

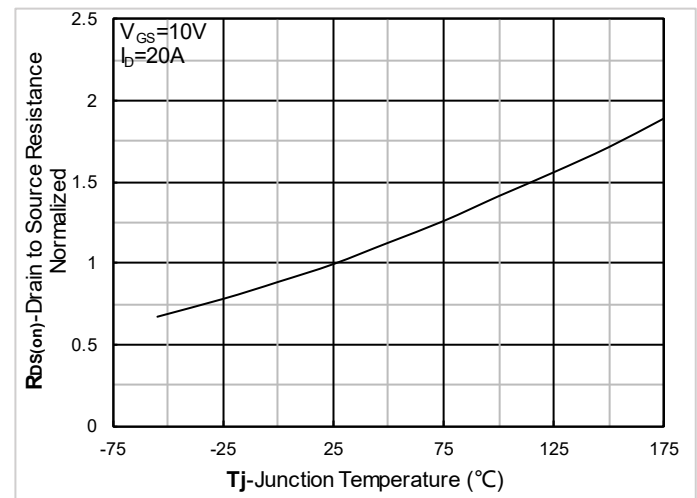

Figure 6. Normalized On-Resistance



# YJGD011G06AQ

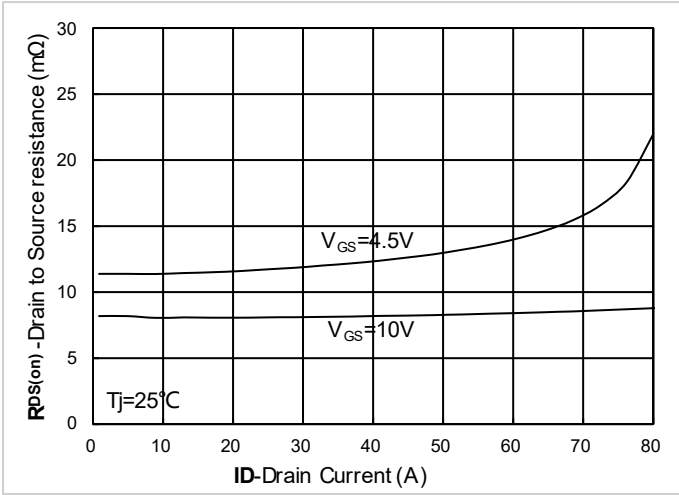

Figure 7. RDS(on) vs. Drain Current; typical values

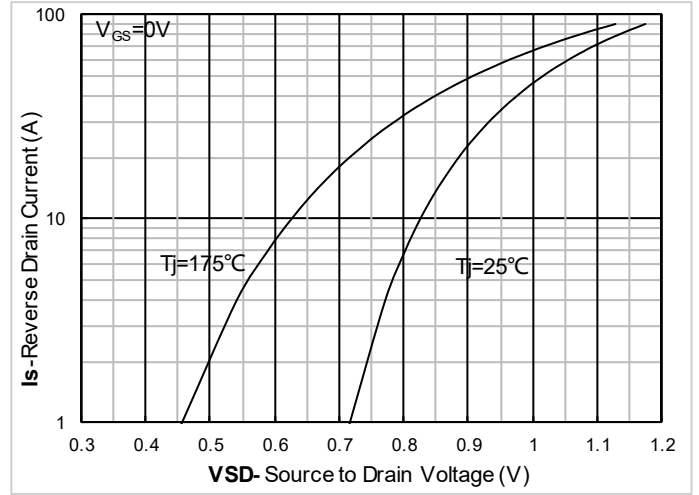

Figure 8. Forward characteristics of reverse diode; typical values

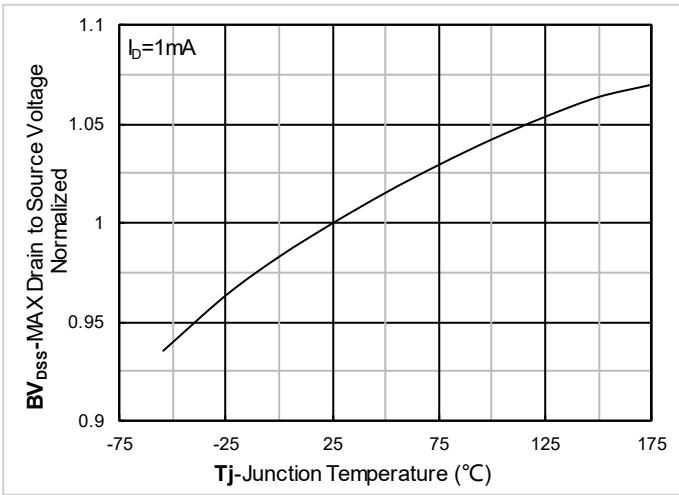

Figure 9. Normalized breakdown voltage

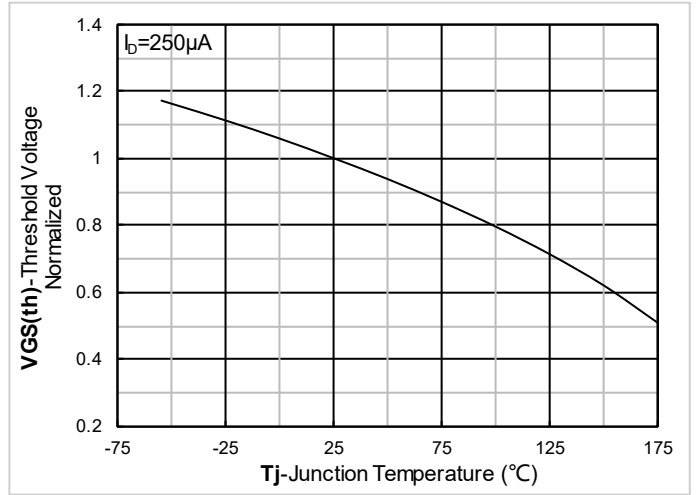

Figure 10. Normalized Threshold voltage

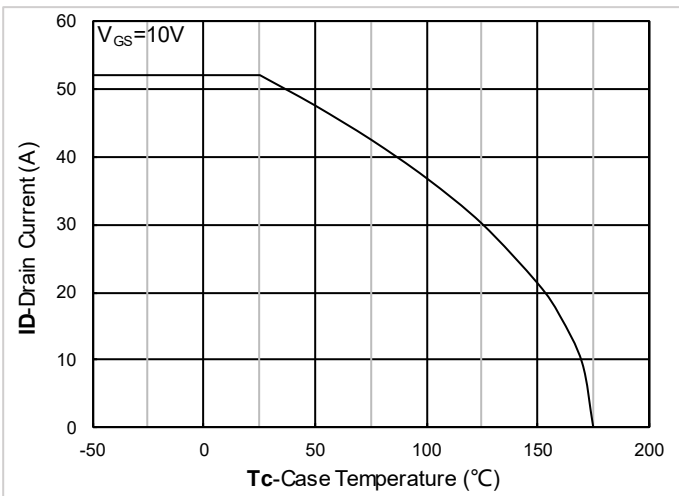

Figure 11. Current dissipation

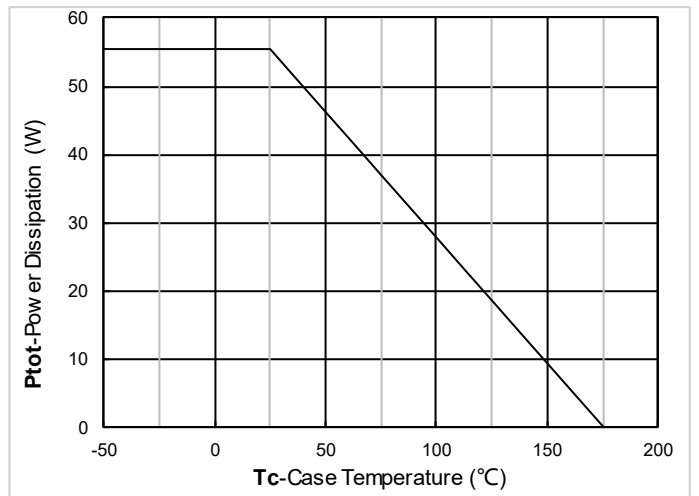

Figure 12. Power dissipation

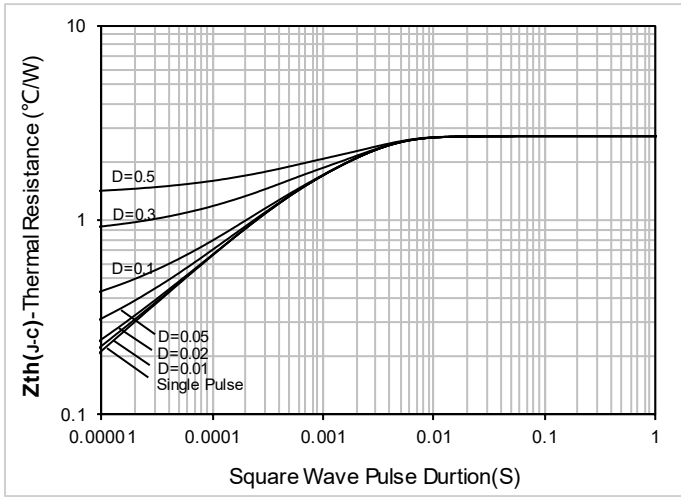

Figure 13. Maximum Transient Thermal Impedance

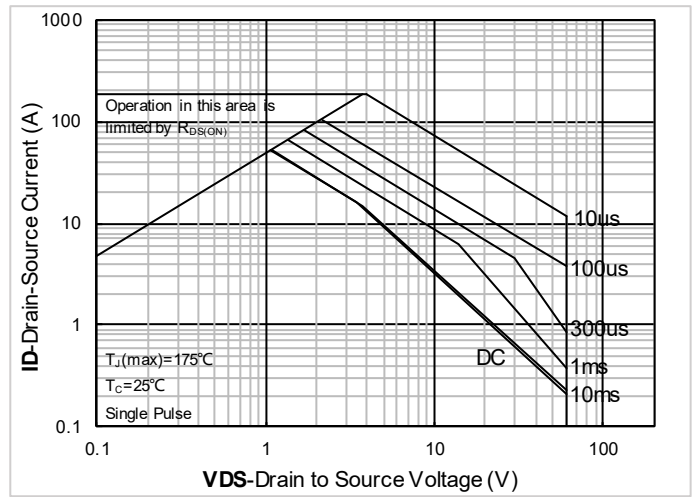

Figure 14. Safe Operation Area

## ■ Test Circuits & Waveforms

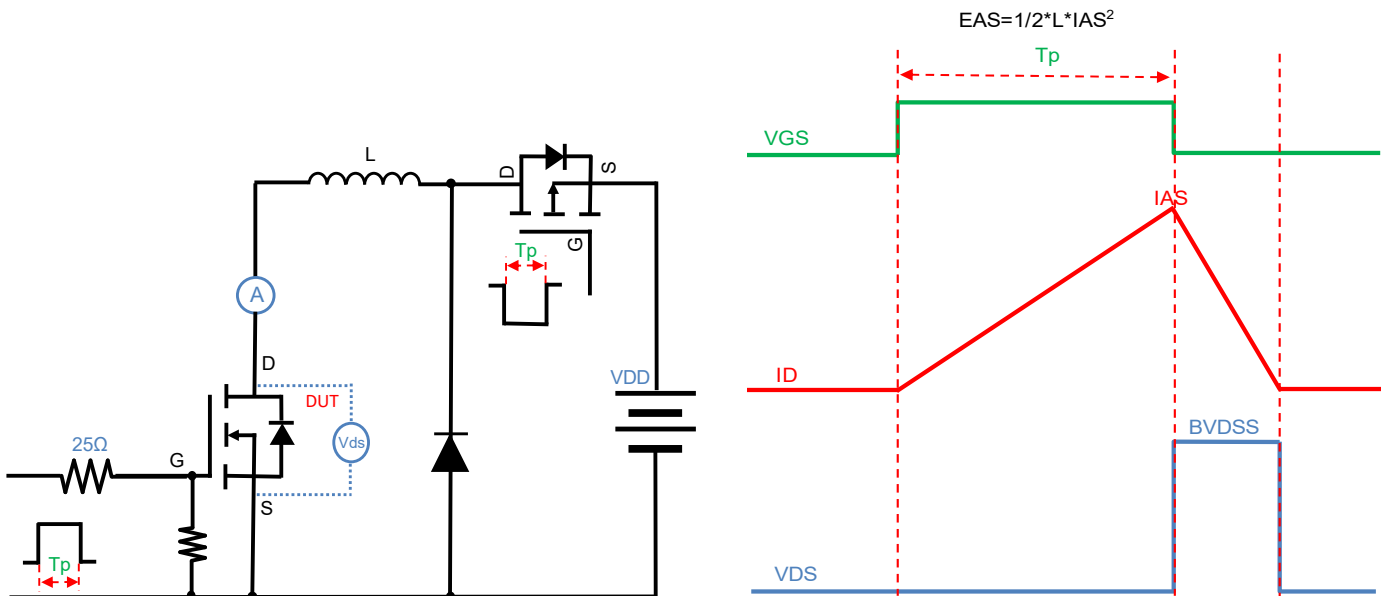

Figure A. Unclamped Inductive Switching (UIS) Test Circuit & Waveform

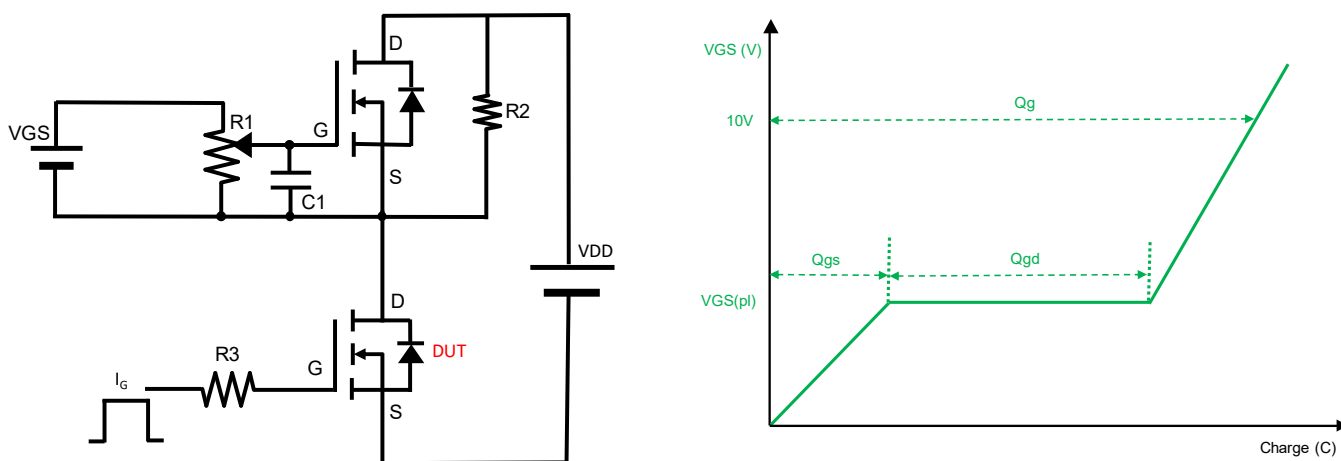

Figure B. Gate Charge Test Circuit & Waveform

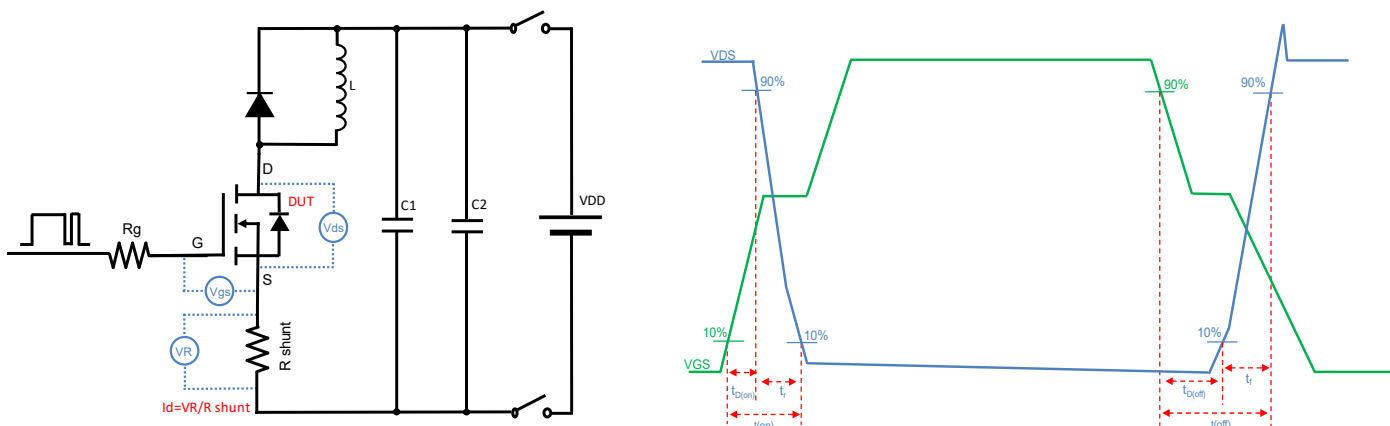

Figure C. Resistive Switching Test Circuit & Waveform

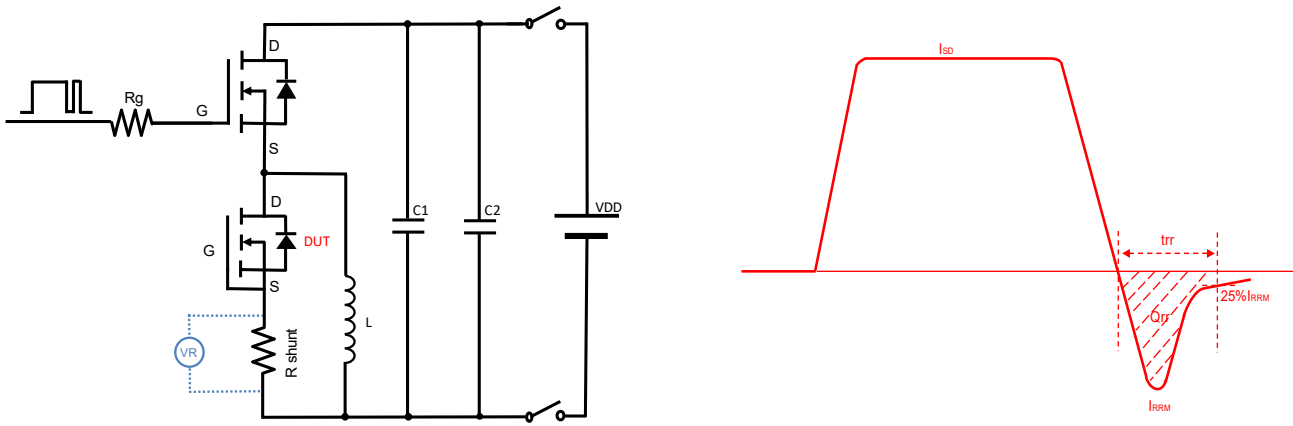
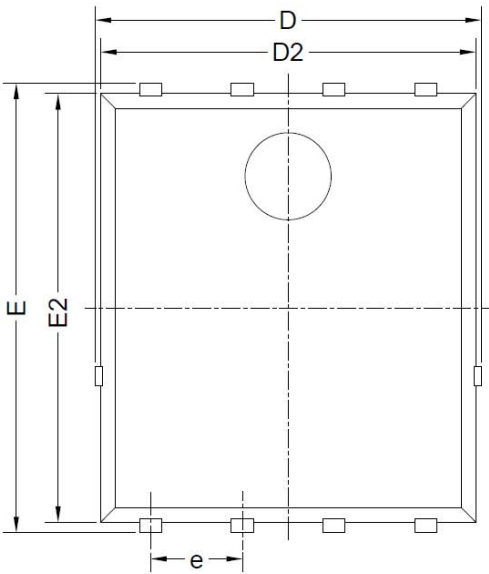

Figure D. Diode Recovery Test Circuit & Waveform



# YJGD011G06AQ

## ■ PDFN5060-8L-E-1.1mm Package information



Top View  
正面视图

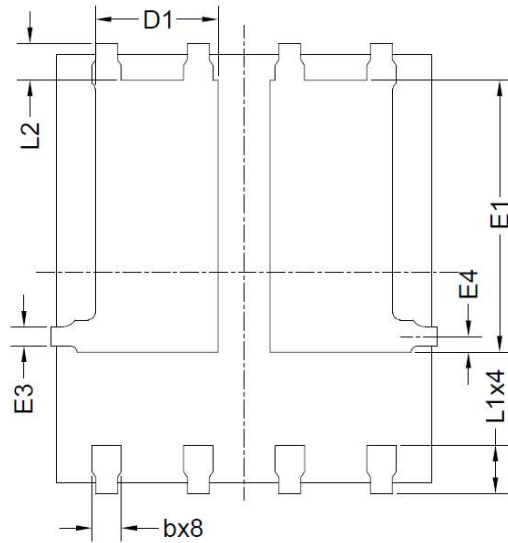

Bottom View  
背面视图

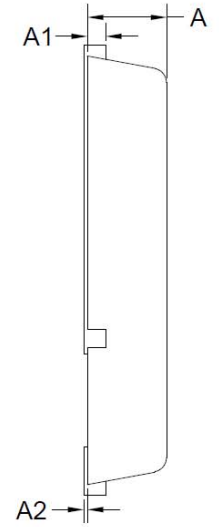

Side View  
侧面视图

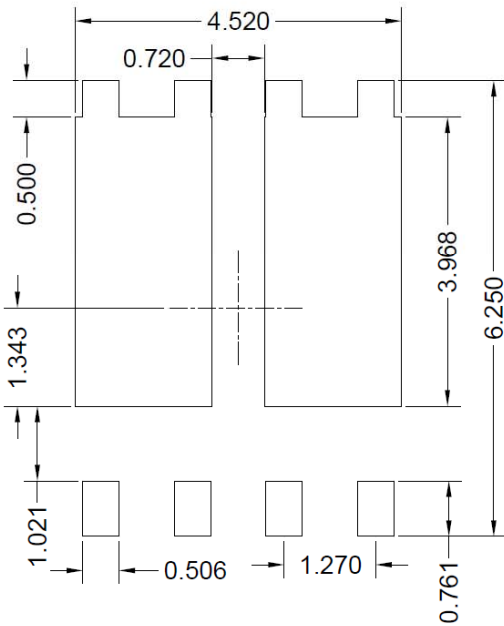

Suggested Solder Pad Layout  
Top View

SYMBOL	MILLIMETER		
	MIN	NOM	MAX
D	5.15	5.35	5.55
E	5.95	6.15	6.35
A	1.00	1.10	1.20
A1	0.254 BSC		
A2			0.10
D1	1.50	1.70	1.90
E1	3.52	3.72	3.92
D2	5.00	5.20	5.40
E2	5.66	5.86	6.06
E3	0.254 REF		
E4	0.21 REF		
L1	0.56	0.66	0.76
L2	0.50 BSC		
b	0.31	0.41	0.51
e	1.27 BSC		

Note:

1. Controlling dimension: in millimeters.
2. General tolerance:  $\pm 0.10$  mm.
3. The pad layout is for reference purposes only.





# YJGD011G06AQ

## ■ Marking Information

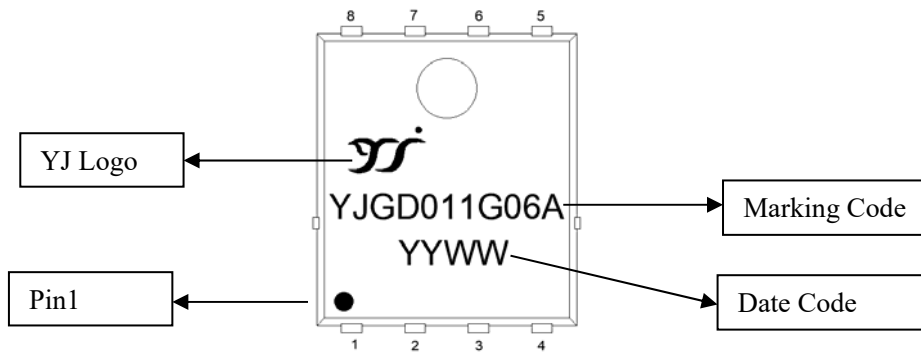

**Note:**

1. All marking is at middle of the product body
2. All marking is in laser printing
3. YJGD011G06A is Marking Code, YYWW is date code, "YY" is year, "WW" is week
4. Body color: Black



## Disclaimer

The information presented in this document is for reference only. Yangzhou Yangjie Electronic Technology Co., Ltd. reserves the right to make changes without notice for the specification of the products displayed herein to improve reliability, function or design or otherwise.

The product listed herein is designed to be used with automotive electronics, are not designed for use in medical, life-saving, lifesustaining, or military, Yangjie or anyone on its behalf, assumes no responsibility or liability for any damages resulting from such improper use of sale.

This publication supersedes & replaces all information previously supplied. For additional information, please visit our website <http://www.21yangjie.com>, or consult your nearest Yangjie's sales office for further assistance.